

ROBERTS

Sound for Generations



RD-20

FM RDS/DAB digital radio



Gemini 20

Please read this manual before use

Contents

<i>Controls</i>	2	<i>Specifications</i>	16
<i>Battery operation</i>	3	<i>Circuit features</i>	16
<i>Mains operation</i>	3	<i>Mains Supply</i>	17
<i>Operating your radio - DAB</i>	4	<i>Guarantee</i>	18
<i>Selecting a station - DAB</i>	5		
<i>Secondary services - DAB</i>	6		
<i>Display modes - DAB</i>	6		
<i>Finding new stations - DAB</i>	7		
<i>Autoselect - DAB</i>	7		
<i>Manual tuning - DAB</i>	8		
<i>Signal strength display - DAB</i>	8		
<i>Operating your radio - FM</i>	9		
<i>Manual tuning - FM</i>	10		
<i>Display modes - FM</i>	11		
<i>FM stereo/mono</i>	11		
<i>Presetting stations - DAB and FM</i>	12		
<i>Recalling a preset station - DAB and FM</i>	13		
<i>System reset</i>	14		
<i>Headphone socket</i>	15		
<i>Display backlight</i>	15		
<i>Line out socket</i>	15		
<i>General</i>	16		

Controls

(Top)

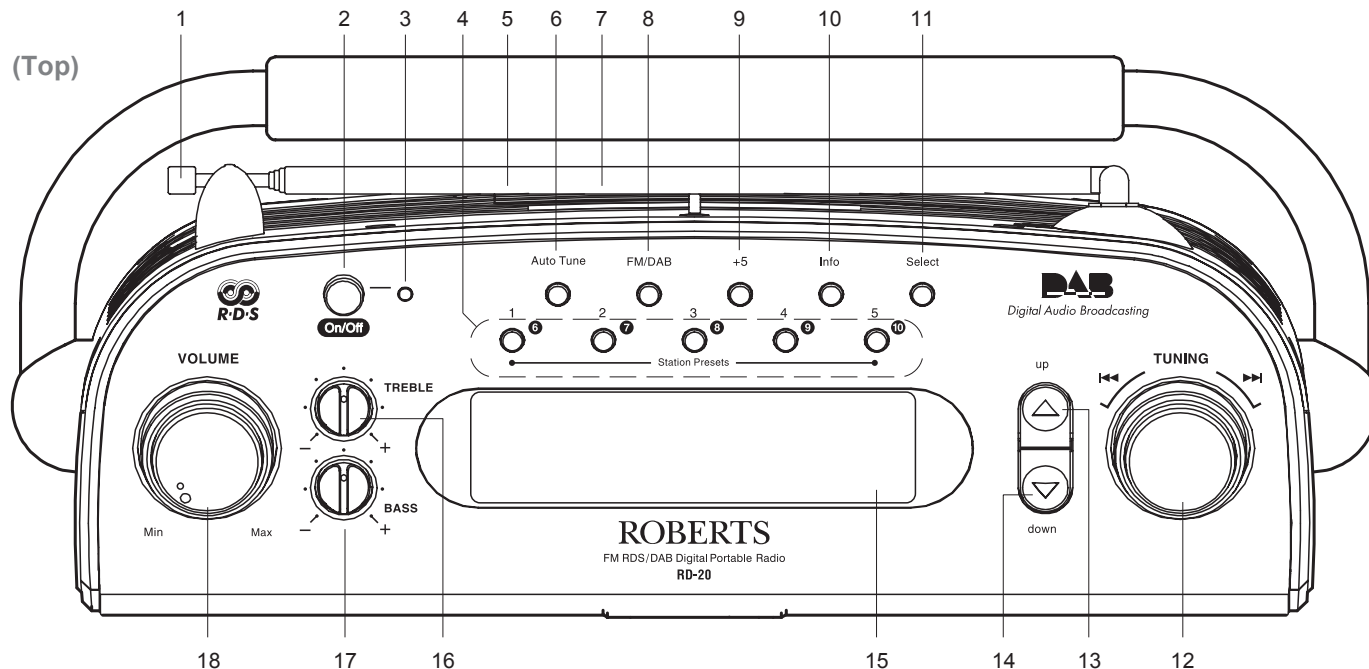

1. Telescopic aerial (on rear)
2. On/Off button
3. Mains LED indicator
4. Station presets
5. Headphone socket (on rear)
6. Auto Tune button

7. Line out socket (on rear)
8. FM/DAB button
9. +5 button
10. Info button
11. Select button
12. Tuning control

13. Tuning up button
14. Tuning down button
15. Liquid crystal display (LCD)
16. Treble control
17. Bass control
18. Volume control

Battery operation

1. Remove the **Battery cover** on the rear of the unit by pushing the battery door in and downwards. .
2. Insert six LR20 (D size) batteries into the spaces in the compartment. Take care to ensure all batteries are inserted with the correct polarity as shown inside the battery compartment. Replace the battery cover.
3. Reduced power, distortion and a 'stuttering' sound are all signs that the batteries may need replacing.
4. If the radio is not to be used for any extended period of time it is recommended that the batteries are removed from the radio.

We would recommend for economy that the RD-20 is used on the mains whenever possible with battery operation for occasional or stand-by use only.

IMPORTANT: The batteries should not be exposed to excessive heat such as sunshine, fire or the like. After use, disposable batteries should if possible be taken to a suitable recycling centre. On no account should batteries be disposed of by incineration.

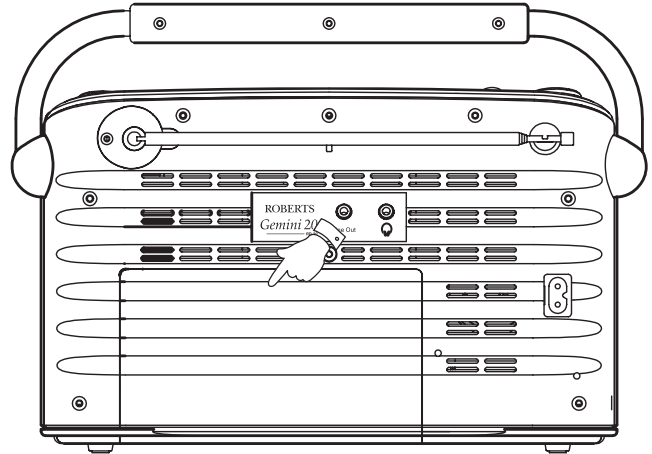

Mains operation

1. Place your radio on a flat surface.
2. Plug the mains lead into the **Socket** located on the rear of your radio ensuring that the plug is pushed fully into the socket.
3. Plug the other end of the mains lead into a wall socket and switch on the wall socket.

IMPORTANT: The mains plug is used as the means of connecting the radio to the mains supply. The mains socket used for the radio must remain accessible during normal use. In order to disconnect the radio from the mains completely, the mains plug should be removed from the mains socket outlet completely.

4. When the mains LED is off, it indicates that the radio is completely disconnected from the mains.

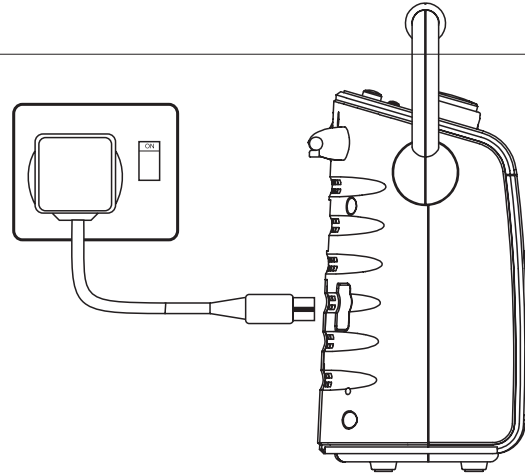

Operating your radio - DAB

1. Fully extend the telescopic aerial
2. Press the **On/Off button** to switch on your radio. The display will show "Roberts DAB digital radio" for a few seconds.
3. If this is the first time the radio is used a quick scan of the UK band III DAB channels will be carried out. The display will show "Autotune Quick scan". If the radio has been used before the last used station will be selected.
4. During Autotune as each group of stations is detected the bottom line of the display will show its name and the station count will be updated. The top line of the display shows a bargraph indicating progress of the Autotune.
5. When the Autotune is complete the first station (in numeric-alpha order 0...9...A....Z) will be selected.
6. If the station list is still empty after the Autotune you radio will display "No Signal".
7. If no signals are found it may be necessary to relocate your radio to a position giving better reception.

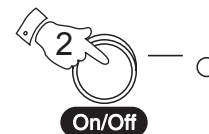

Roberts

Autotune
Quick scan

■■■■□□□□□□□□
Searchin9...

■■■■■■■■■■□□□□ 24
BBC National DAB

1Xtra DAB
BBC National DAB

No signal DAB

Selecting a station - DAB

1. The top line of the display shows the name of the station currently selected.
2. Rotate the **Tuning control** or press the **Up** or **Down buttons** to scroll through the list of available stations.
3. Press and release the **Select button** to select the station. The display may show "Tuning" while your radio finds the new station.
4. Adjust the **Volume and Tone controls** to the required settings.

Note: If after selecting a station the display shows "Not Available" it may be necessary to relocate your radio to a position giving better reception.

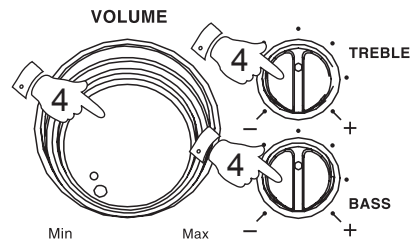
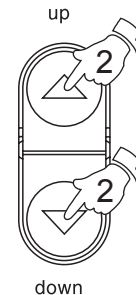
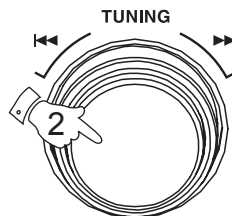

Secondary services - DAB

1. Certain radio stations have one or more secondary services associated with them. If a station has a secondary service associated with it the display will show ">" next to the station name on the station list. The secondary service will then appear immediately after the primary service as you turn the tuning control.



BBC5Live> DAB
■■■■■□■■■■



>BBC SprtX DAB
■■■■■□■■■■

Display modes - DAB

Your radio has five display modes:-



1. Press the **Info button** to cycle through the various modes.
 - a. Scrolling text Displays scrolling text messages such as artist/track name, phone number etc.
 - b. Program Type Displays type of station being listened to e.g. Pop, Classic, News etc.
 - c. Multiplex Name Displays name of multiplex to which current station belongs.
 - d. Signal strength Displays signal strength for station being listened to.
 - e. Time and date Displays current time and date.

a BBC 7 DAB
Just a Minute...

b BBC 7 DAB
Culture

c BBC 7 DAB
BBC National DAB

d BBC 7 DAB
■■■■■□■■■■

e BBC 7 DAB
19:17 08-06-2003

Finding new stations - DAB

As time passes new stations may become available. To find new stations proceed as follows:-

1. Press and release the **AutoTune button**, the display will show Autotune Quick scan. Your radio will perform a scan of the UK DAB frequencies. As new stations are found the station counter on the right-hand side of the display will increase and stations will be added to the list
2. To carry out a full scan of the entire DAB band III frequencies press and hold down the **AutoTune button** for more than 2 seconds and then release. The display will show Autotune Full scan. As new stations are found the station counter on the right-hand side of the display will increase and stations will be added to the list



Autotune
Quick scan



Autotune
Full scan

Autoselect - DAB

As an alternative to pressing the **Select button** to select a station your radio can be set so as to automatically select a station.

1. Rotate the **Tuning control** a few clicks in either direction, immediately press and hold down the **Select button** until the display shows Autoselect ON.
2. Rotate the Tuning **control** or press the **Up** or **Down buttons** until the station you require is visible on the display. After a few seconds your radio will automatically select the station shown on the display.
3. To switch off autoselect rotate the **Tuning control** a few clicks in either direction, immediately press and hold down the **Select button** until the display shows Autoselect OFF.

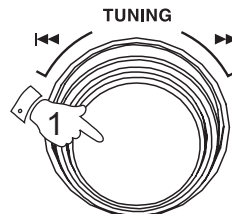

Autoselect ON



Autoselect OFF

Manual Tuning - DAB

Manual tuning allows you to tune directly to the various band III DAB channels. UK DAB stations are currently located in the range 11B to 12D.

1. Press and hold down the **Select button** until the display shows Manual tune. Release the **Select button**.
2. Rotate the **Tuning control** or press the **Up** or **Down buttons** to select the required DAB channel.
3. Press and release the **Select button** to select the channel.
4. Rotate the **Tuning control** or press the **Up** or **Down buttons** to select the stations contained within the Multiplex (group of stations) for the selected DAB channel.
5. Press and release the **Select button** to return to normal tuning mode.

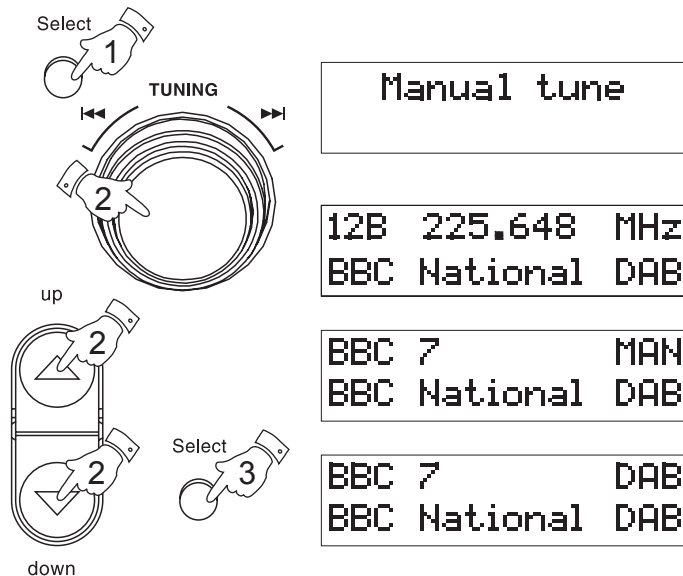

Signal strength display - DAB

1. Repeatedly press and release the **Info button** until the lower line of the display shows signal strength - see diagram.
2. Your radio can now be positioned for best reception using the signal strength display as guide. Move your radio around and position your radio so as to give maximum number of black rectangles on signal strength display.
3. The clear unfilled rectangle indicates minimum signal level required for satisfactory reception.



If you need any further advice, please call our Technical Helpline on :-
020 8758 0338 (Mon-Fri)

Operating your radio - FM

1. Carefully extend the telescopic aerial
2. Press the **On/Off button** to switch on your radio. The display will show "Roberts DAB digital radio" for a few seconds.
3. Press the **FM/DAB button** to select the FM band.
4. Press and hold down either the **Up or Down buttons** until the frequency in the display begins to change rapidly. Release the button. Your radio will scan the FM waveband, stopping each time it finds a station of sufficient strength.
5. After a few seconds the display will update and show station name.
6. To find other stations press hold down the **Up or Down button** as before.
7. When the waveband end is reached your radio will recommence tuning from the opposite waveband end.
8. Adjust the **Volume and Tone controls** to the required settings.
9. To switch off your radio press the **On/Off button**.

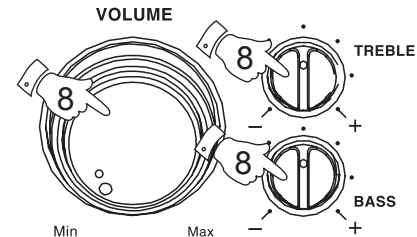
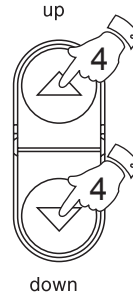
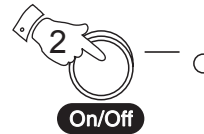

Manual tuning - FM

1. Press the **On/Off button** to switch on your radio.
2. Press the **FM/DAB button** to select the FM band. Fully extend the **Telescopic aerial**.
3. Rotate the **Tuning control** or press the **Up** or **Down buttons** to tune to a station. The frequency will change in steps of 50kHz.
4. When the waveband end is reached the radio will recommence tuning from the opposite waveband end.
5. Set the **Volume control** and **Tone controls** to the desired settings.
6. To switch off your radio press the **On/Off button**.

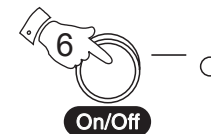
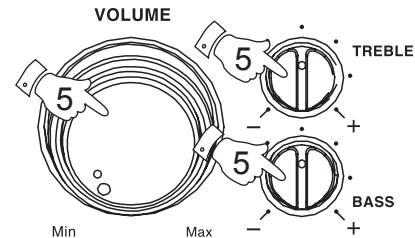
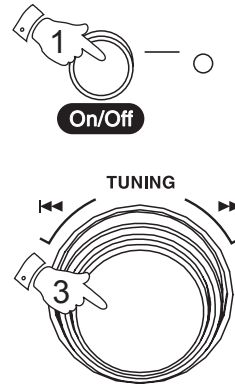

Display modes - FM

On FM the bottom line of the display can be set to any of the following modes:-

1. Press the **Info button** to cycle through the various modes.

- a. Scrolling text Displays scrolling text messages such as artist/ track name, phone in number etc.
- b. Program Type Displays type of station being listened to e.g. Pop, Classic, News etc.
- c. Signal strength Displays signal strength for station being listened to.
- d. Time and date Displays current time and date.
- e. Frequency Displays frequency of the station being listened to.
- f. Audio mode Display shows Auto (stereo) or mono.

FM Stereo/Mono

1. If a station being received is weak some hiss may be audible. To reduce the hiss press and hold in the **Select button** until the display shows Audio mode : Mono, your radio will switch to mono mode.
2. To return to stereo mode press and hold in the **Select button** until the display shows Audio mode :Auto, your radio will switch to stereo mode.

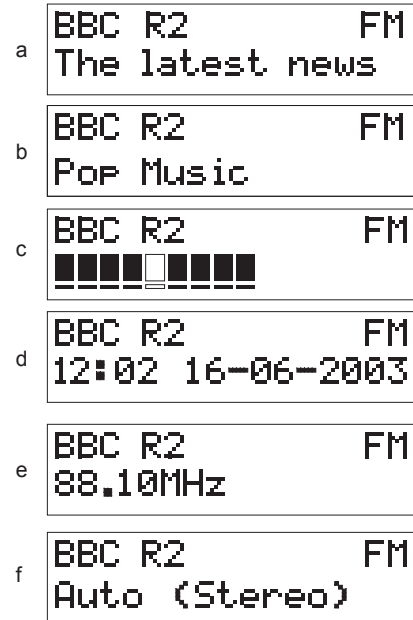

Presetting stations - DAB and FM

There are 10 memory presets for each of the 2 wavebands.

1. Press the **On/Off button** switch on the radio.
2. Tune to the required station as previously described.
3. Press and hold down the required **Preset button** until the display shows e.g. Preset 1 stored. The station will be stored under the chosen preset button. Repeat this procedure for the remaining presets.
4. Presets 6 to 10 are obtained by pressing **+5** followed by **Preset button 1 to 5**. e.g preset 7 can be be set by pressing **+5** followed by holding down **Preset button 2** until the display shows Preset 7 stored.
5. Stations stored in preset memories may be overwritten by following the above procedure.

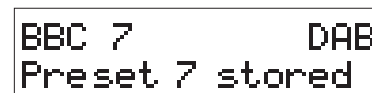
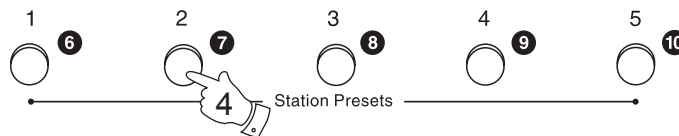
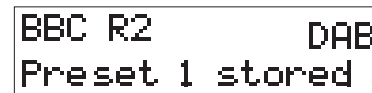
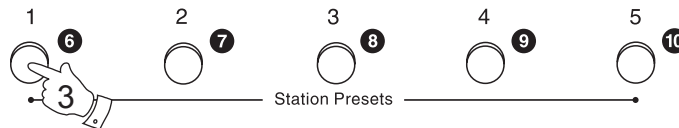
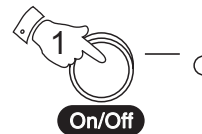

Recalling a preset station - DAB and FM

1. Press the **On/Off button** to switch on the radio.
2. Select the required waveband by pressing the **FM/DAB** button.
3. Momentarily press the required **Preset button**, your radio will tune to the station stored in preset memory.
4. Presets 6 to 10 are obtained by pressing **+5** and **Preset button 1 to 5**. e.g preset 7 can be recalled by pressing **+5** followed by **Preset button 2**

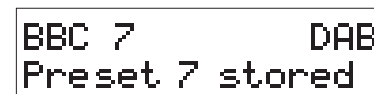
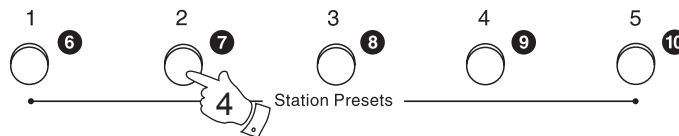
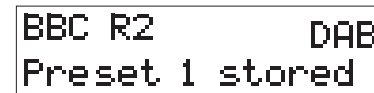
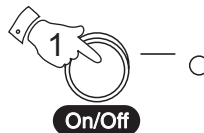

System reset

If your radio fails to operate correctly, or some digits on the display are missing or incomplete carry out the following procedure.

1. Switch off your radio
2. Switch on your radio - before the screen shows Roberts DAB digital radio press and hold down the **Select button** until the display shows System Reset.
3. A full reset will be performed all presets and station lists will be erased.
4. If DAB was used last then a quick scan of the UK band III DAB channels will be carried out, otherwise a quick scan of the UK band III DAB channels will be carried out the next time the DAB band is selected.

If a problem persists our technical staff would be pleased to help offer any assistance on operating the radio. Our technical helpline number is 020 8758 0338.

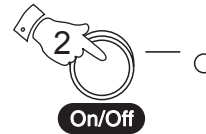
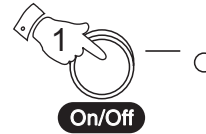

System reset

Autotune
Quick scan

■■■■■■■■■■■■■■■■■■■■
Searching...

■■■■■■■■■■■■■■■■■■■■ 24
BBC National DAB

Headphone socket

A 3.5mm **Headphone Socket** located on the rear of your radio is provided for use with either headphones or an earpiece. Inserting a plug automatically mutes the internal loudspeaker.

IMPORTANT: Excessive sound pressure from earphones and headphones can cause hearing loss.

Line out socket

A 3.5mm **Line out socket** located on the rear of your radio is provided for connecting the audio signal to an external amplifier. Inserting a line out audio cable will not mute the internal loudspeaker. Set the volume control to minimum if desired.

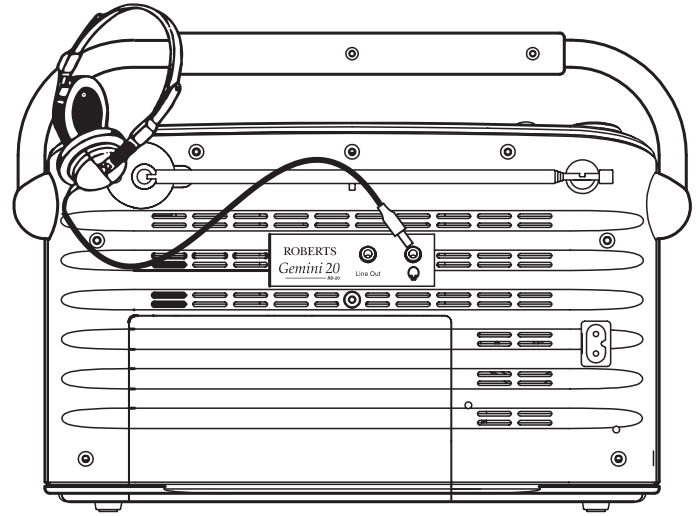

Display backlight

1. When your radio is powered by batteries the display backlight will be switched on for approximately 12 seconds when any button is pressed.
2. When your radio is powered by AC mains the display backlight will always be switched on.

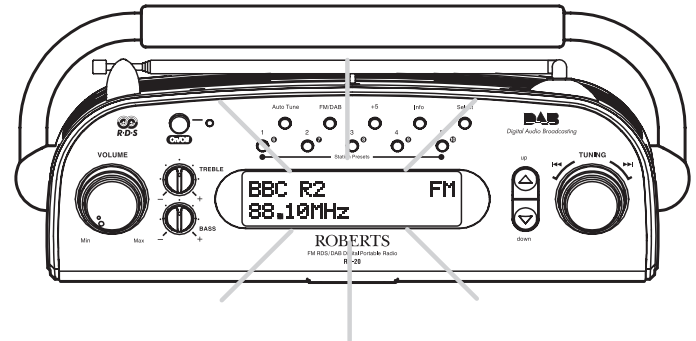

General

Do not allow this radio to be exposed to water, steam or sand. Do not leave your radio where excessive heat could cause damage such as in a parked car where the heat from the sun can build up even though the outside temperature may not seem too high. It is recommended that the DAB band be used wherever possible as better results in terms of quality and freedom from interference will usually be obtained than on the FM band.

In case of malfunction due to electrostatic discharge reset your radio following the procedure on page 14 (reconnect of power source may be required) to resume normal operation.



- No objects filled with liquids such as vases, shall be placed on the radio.
- It is recommended to operate the product such that there is a minimum distance (10cm recommended) to adjacent objects in order to ensure good ventilation.
- The ventilation of the product should not be restricted by covering it or its ventilation openings with items such as newspapers, tablecloths, curtains etc.
- No naked flame sources such as lighted candles should be placed on the product.
- It is recommended to avoid using or storing the product at extremes of temperature. Avoid leaving the unit in cars, on window sills in direct sunlight etc.
- The nameplate is located on the underside of your radio.

Specifications

Power Requirements

Mains AC 230 volts, 50Hz  only
Batteries 6 x LR20 (D size)

Battery Life

Approx. 28 hours of listening for 4 hours a day at normal volume using alkaline cells.

Frequency Coverage

FM 87.5-108MHz
DAB 174.928 - 239.200MHz

Circuit Features

Loudspeaker	2 x 79mm 4ohms
Output Power	3W into 4ohms
Headphone socket	3.5mm dia
Line out socket	3.5mm dia
Aerial System FM	Telescopic aerial
DAB	Telescopic aerial

Mains supply

The RD-20 will operate from a supply of AC 230 volts, 50Hz \sim only.

DO NOT cut off the mains plug from this equipment. If the plug fitted is not suitable for the power points in your home or the cable is too short to reach a power point, then obtain an appropriate safety approved extension lead or adaptor. If in doubt consult your dealer.

If nonetheless the mains plug is cut off, remove the fuse and dispose of the plug immediately to avoid a possible shock hazard by inadvertent connection to the mains supply.

If this product is not supplied with a mains plug, or one has to be fitted, then follow the instructions given below:

IMPORTANT. DO NOT make any connection to the larger terminal which is marked with the letter E or by the safety earth symbol \perp or coloured Green or Green-and-yellow.

The wires in the mains lead are coloured in accordance with the following codes :-

BLUE - NEUTRAL

BROWN - LIVE

The wire coloured BLUE must be connected to the terminal marked N or coloured BLACK.

The wire coloured BROWN must be connected to the terminal marked L or coloured RED.

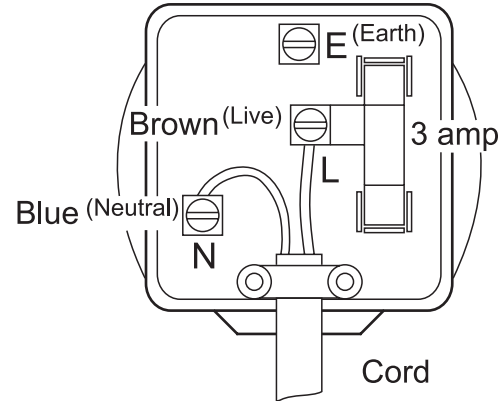

Fuse

When replacing the fuse only a 3A ASTA approved to BS1362 type should be used and be sure to re-fit the fuse cover.

IF IN DOUBT - CONSULT A QUALIFIED ELECTRICIAN.

Replacement fuse holders are available from Roberts Radio Technical Services at the address shown on the rear of this manual.

Guarantee

This instrument is guaranteed for twelve months from the date of delivery to the original owner against failure due to faulty workmanship or component breakdown, subject to the procedure stated below. Should any component or part fail during this guarantee period it will be repaired or replaced free of charge.

The guarantee does not cover:

1. Damage resulting from incorrect use.
2. Consequential damage.
3. Receivers with removed or defaced serial numbers.

N.B. Damaged or broken telescopic aerials will not be replaced under guarantee.

Procedure:

Any claim under this guarantee should be made through the dealer from whom the instrument was purchased. It is likely that your Roberts' dealer will be able to attend to any defect quickly and efficiently, but should it be necessary the dealer will return the instrument to the company's service department for attention. In the event that it is not possible to return the instrument to the Roberts' dealer from whom it was purchased, please contact Roberts Radio Technical Services at the address shown on the rear of this manual.



ROBERTS RADIO TECHNICAL SERVICES

97-99 Worton Road

Isleworth Middlesex

TW7 6EG

Technical Helpline :- 020 8758 0338 (*Mon-Fri during office hours*)

Website: <http://www.robertsradio.co.uk>

